

TERA™ 4-pair outlet termination instructions

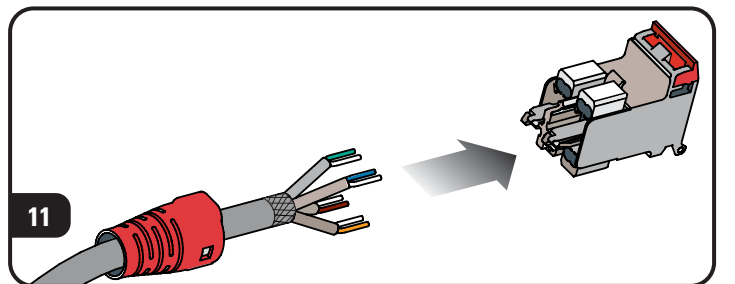

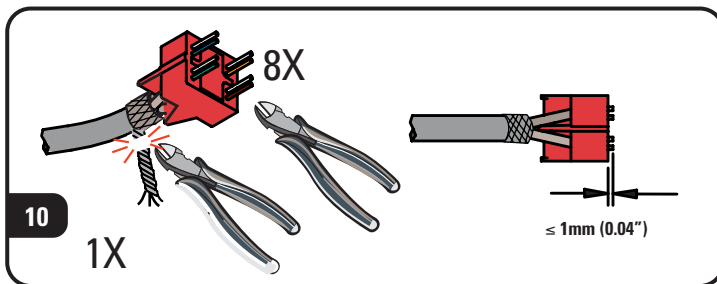
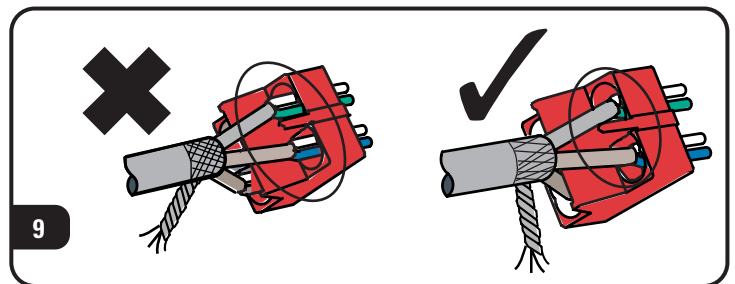
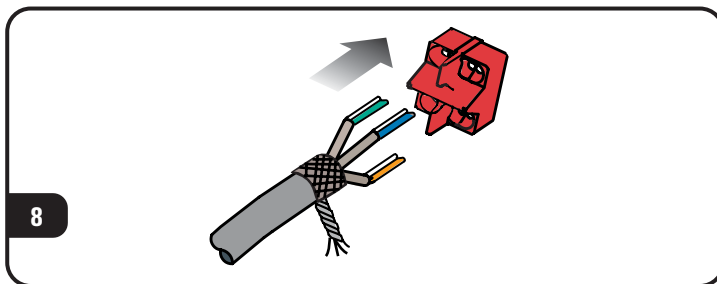
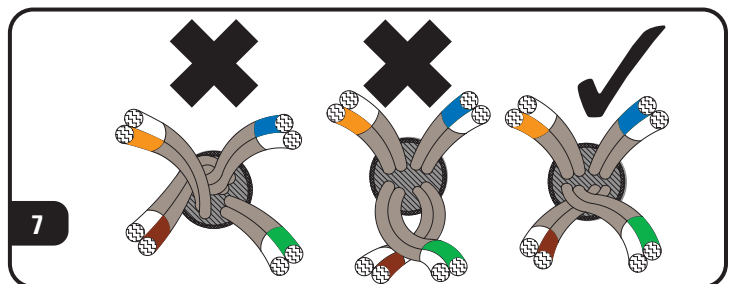
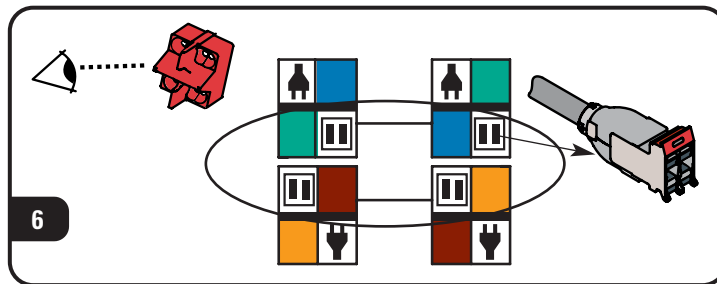
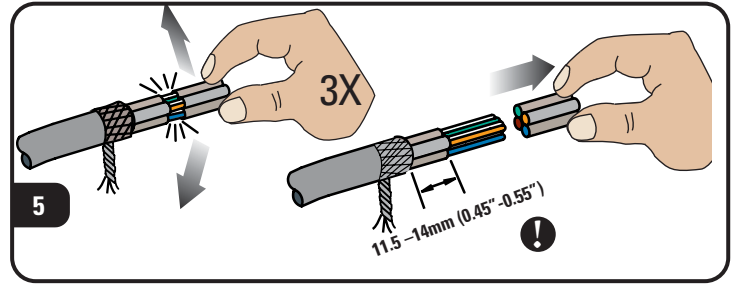
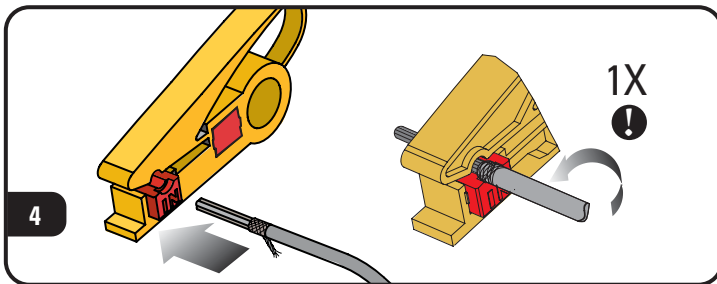
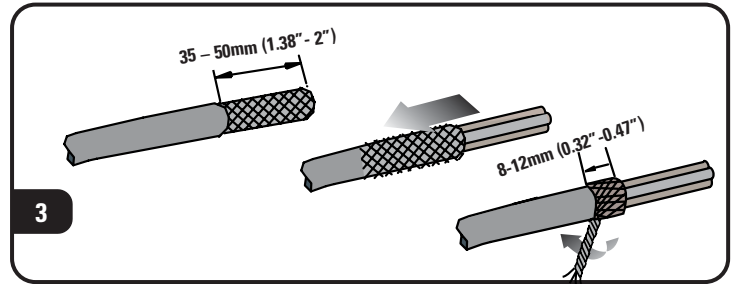
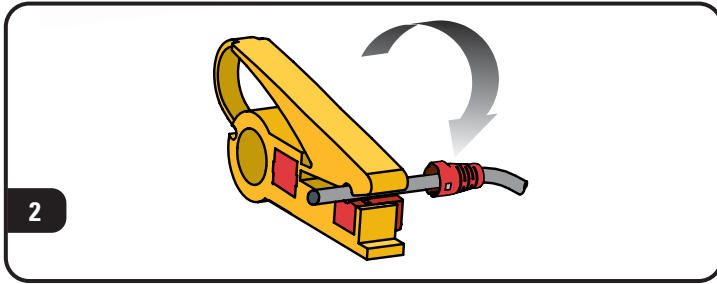
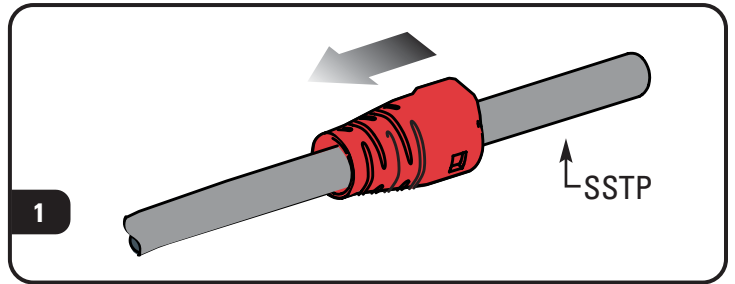
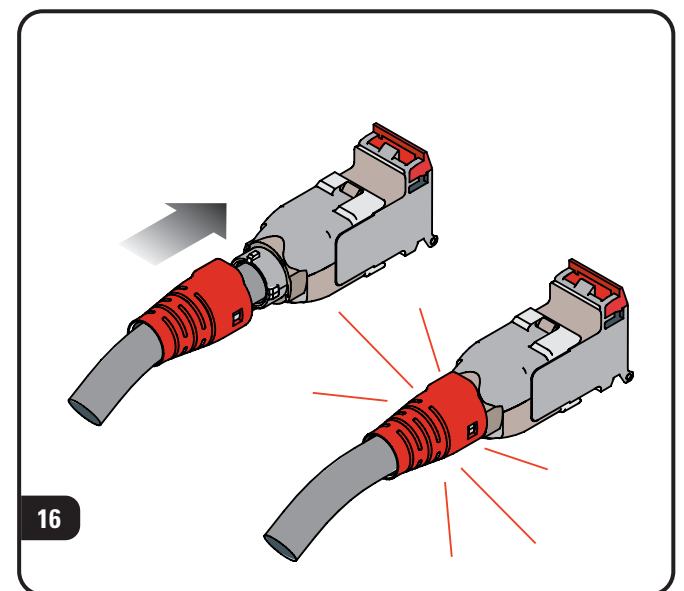
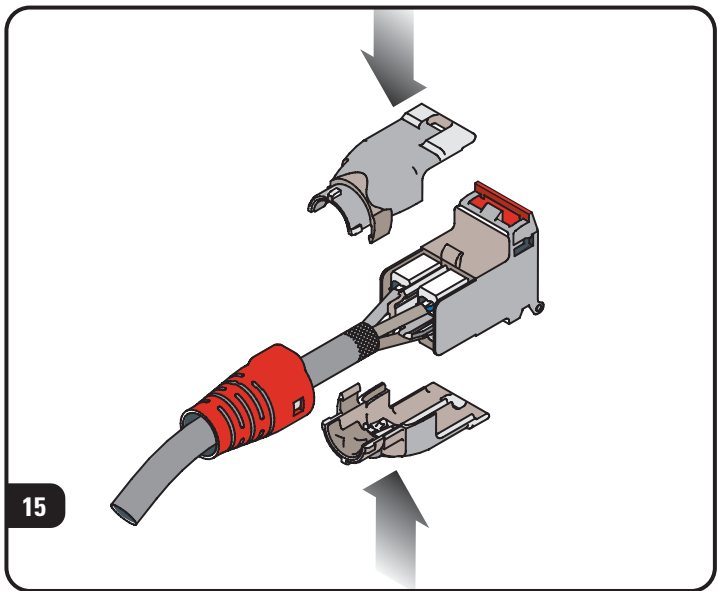
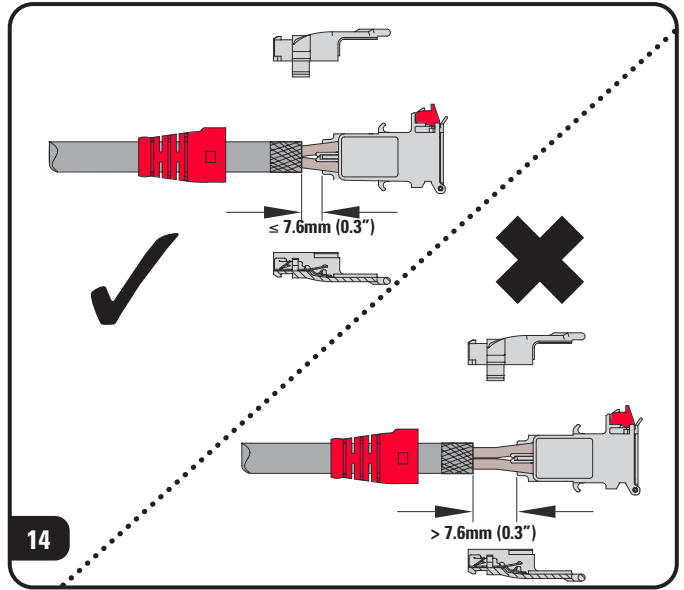
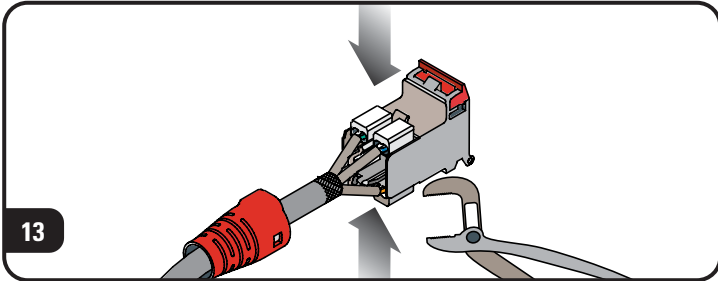
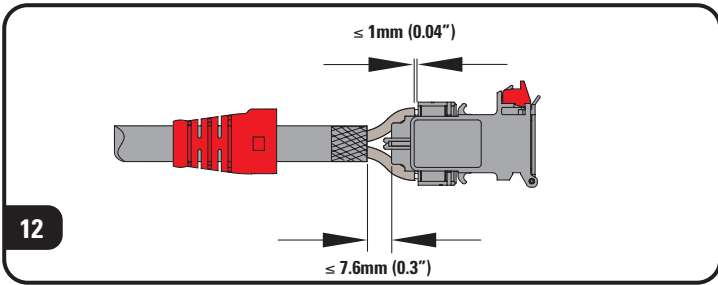

To assist safe installations, comply with the following:

- A. Use caution when installing or modifying telecommunications circuits.
- B. Never touch uninsulated wire terminals unless the circuit has been disconnected.
- C. Never install this device in a wet location.
- D. Never install wiring during a lightning storm.



Siemon — Australia
 Sydney, Australia
 Tel: (61) 2 9452 2666

Siemon — China
 Beijing, P.R. China
 Tel: (86) 10 6559 8860

Siemon — Germany
 Frankfurt, Germany
 Tel: (49) (0) 69 97168 184

Siemon — Latin America
 Coral Gables, Florida USA
 Tel: (1) 305 446 9150

Siemon — Southeast Asia
 Singapore
 Tel: (65) 345 9119

Siemon — USA
 Watertown, Connecticut
 Tel: (1) 866-548-5814

Siemon — Canada
 Markham, Ontario
 Tel: (1) 905 940 9223

Siemon — France
 Paris, France
 Tel: (33) 1 46 46 11 85

Siemon — Italy
 Milano, Italy
 Tel: (39) 02 64 672 209

**Latin American Sales
 Manufacturer's Reps**
 Castroville, Texas USA
 Tel: (1) 830 538 6375

Siemon — UK
 Woking, England
 Tel: (44) (0) 1483 480040

