

FLUKE®

Model 65 *Infrared Thermometer*

Instruction Sheet

Introduction

The Fluke Model 65 Infrared Thermometer (“the thermometer”) is a noncontact thermometer with laser pointer. The thermometer determines an object's surface temperature by measuring the amount of infrared energy radiated by the surface.

Noncontact thermometers can be used to measure surface temperatures that are unsuitable for traditional contact measurement methods (such as moving objects, electrically live surfaces, and difficult-to-reach objects).

Box Contents

Thermometer, holster, carrying case, 2 AA alkaline batteries (not installed), Instruction Sheet, Quick Reference Card, and Registration Card.

Contacting Fluke

To contact Fluke call:

- 1-888-993-5853 in USA and Canada
- +31-402-678-200 in Europe
- +81-3-3434-0181 Japan
- +65-738-5655 Singapore
- +1-425-356-5500 in other countries

Visit Fluke's web site at: www.fluke.com.

⚠Warning

To avoid possible personal injury:

- ⇒ **Caution - performance of procedures other than those specified herein may result in hazardous light exposure.**
- ⇒ **Do not stare into the laser beam or direct it toward the eyes.**

Caution

To avoid possible damage to the thermometer or incorrect measurements:

- ⇒ **Do not drop the thermometer or subject it to violent shocks.**
- ⇒ **Do not operate the thermometer near large electrical or magnetic fields.**
- ⇒ **Do not touch the object with the thermometer.**
- ⇒ **If the emissivity of the object is not 0.95, the thermometer can indicate a temperature different from the actual temperature. (See "Emissivity.")**
- ⇒ **Keep the thermometer away from direct sunlight or a strong source of light, hot objects (70 °C / 158 °F), high temperatures, high humidity, or dust during use and storage.**
- ⇒ **Do not apply sudden temperature changes to the thermometer. Before taking measurements, wait for the thermometer to return to a stable temperature.**
- ⇒ **Do not touch the focal lens.**
- ⇒ **Condensation may form on the focal lens if the thermometer moves quickly from a cold to a hot environment. Before taking measurements, wait for the condensation to dissipate.**



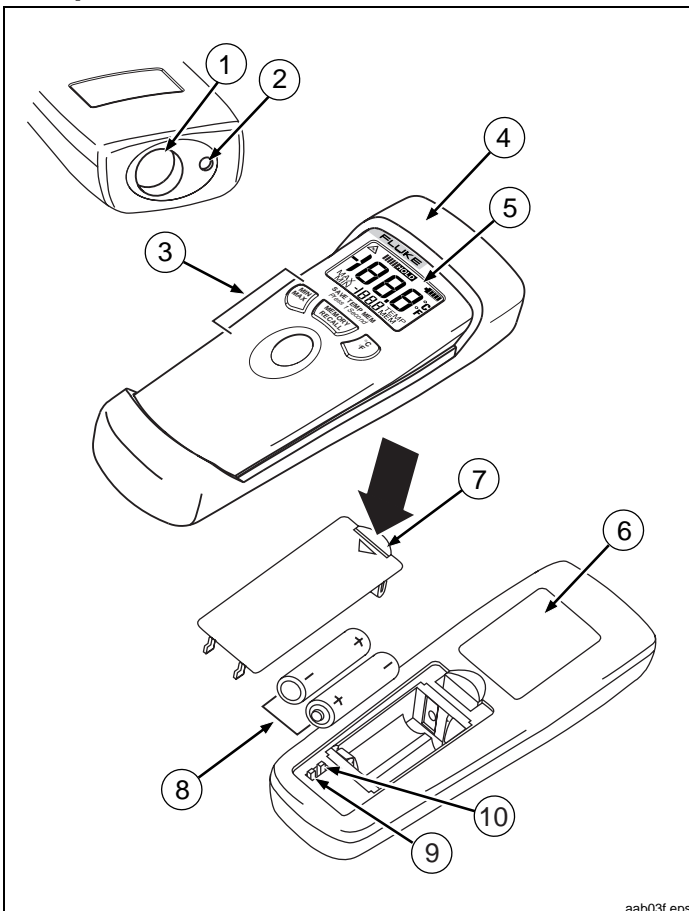











Components



aab03f.eps

①	Focal lens
②	Laser aperture
③	Pushbuttons
④	Holster
⑤	Display
⑥	Laser safety label
⑦	Battery door release
⑧	Batteries
⑨	Backlight switch
⑩	Laser switch

Pushbuttons

Pushbutton	Description
	<p>Press and hold  to display the object's surface temperature. The thermometer clears any stored maximum and minimum temperatures. The laser pointer only activates if the laser switch is in the on position.</p> <p>While  is pressed, the display shows .</p> <p>Release  to stop measuring temperatures and deactivate the laser. The display continues to show the most recent temperature and HOLD for 20 seconds. Then the display turns off.</p>
	<p>Press  to display the maximum measured temperature. The display shows MAX.</p> <p>Press  a second time to display the minimum measured temperature. The display shows MIN.</p> <p>Press  a third time to turn off this function.</p>
	<p>Press  and hold for 1 second to save the displayed temperature. The display flashes TEMP MEM 5 times to indicate that the operation is successful.</p> <p>Press  to display a stored temperature. The display shows TEMP MEM. Press  again to turn off this function.</p>
	<p>Press  to switch between °C and °F.</p>

Pressing any of the three top pushbuttons wakes up the thermometer.

Display Elements

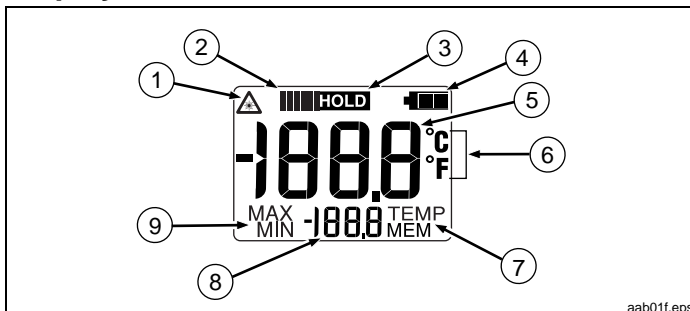

aab01f.eps

①	Laser-enabled indicator
②	Measurement activity indicator
③	Temperature hold indicator
④	Battery level indicator
⑤	Measured surface temperature value
⑥	Celsius or Fahrenheit mode
⑦	Stored temperature indicator
⑧	Maximum, minimum, or stored temperature value
⑨	Maximum or minimum temperature indicator

Ensuring Accuracy

Emissivity

Emissivity is a value between 0 and 1 that indicates an object's ability to emit infrared energy. Emissivity is determined primarily by the object's composition and surface finish. A polished, non-oxidized metallic surface has an emissivity value near 0 and a dull, black surface has an emissivity value near 1. (See "Emissivity of Common Materials.")

The thermometer's sensitivity to emissivity is set at the factory to 0.95. If the emissivity of the object is not 0.95, the displayed temperature could differ from the actual surface temperature. To reduce this difference, apply black tape, black matte paint, or black magic marker to the object if it is safe to do so and measure the darkened surface.

Optical Resolution

Optical resolution (also called "Field of View" or "Distance-to-Spot-Size Ratio") is the ratio of the thermometer's distance from the object's surface to the size of the area measured ("spot size"). The closer the thermometer is to the object, the smaller the spot size. The laser spot size does not indicate the measured spot size. (See "Laser Offset.")

The thermometer has an 8:1 optical resolution:

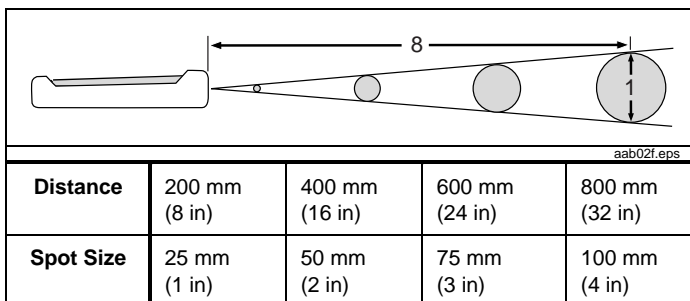

The minimum spot size is 25 mm (1 in), which occurs at a distance of 200 mm (8 in) from the object. You cannot measure a smaller spot size by getting closer.

The temperature displayed is an average temperature within the spot size. Hot spots can be missed if the spot size is too large. Get as close as possible but no closer than 200 mm (8 in).

Laser Offset

The laser beam is offset 18 mm (0.75 in) from the focal lens. Choose a sampling spot large enough to include the laser offset.

Surface Temperatures

The thermometer measures the first surface it detects, even a glass cover, dust, or fog. Make sure the object is not obstructed.

Measuring Temperatures

Read the section "Ensuring Accuracy " before measuring temperatures. Check that the batteries are installed and the laser switch is in the on position. (See the sections "Installing the Batteries" and "Setting the Switches.")

To take a measurement:

1. If the emissivity of the object is different from 0.95, apply black tape, black matte paint, or black magic marker to the object if it is safe to do so. (See the section "Emissivity of Common Materials.")
2. Point the thermometer at the object.
3. Press \bigcirc and aim the laser beam in the center of the area to be measured. The display shows the measured temperature.

Out-of-Range Temperatures

The display indicates when a measured temperature reaches the detection limits of the thermometer. When you recall an out-of-range temperature, the display shows "Lo" and "Hi" as "---."

Temperature	Display
511 °C (951 °F)	Out of range. "Hi" flashes.
500 °C (932 °F)	Temperature flashes.
-40 °C (-40 °F)	Temperature does not flash.
-50 °C (-58 °F)	Temperature flashes.
	Out of range. "Lo" flashes.

aab04f.eps



Maintenance

Installing the Batteries

Remove the holster before replacing the battery or setting the switches.

Caution

- ⇒ **Match the + and – polarities of the battery with the battery case.**
- ⇒ **Do not attempt to recharge the batteries.**
- ⇒ **Do not throw batteries into a fire.**
- ⇒ **Follow local laws or regulations when disposing batteries.**

The  indicates battery life remaining. Replace both batteries when  starts blinking.

Cleaning the Focal Lens

Do not use solvents to clean the focal lens. Blow off loose particles using clean, dry compressed air. Gently brush remaining debris away with a camel hair brush or high-quality lens tissue. The tissue may be moistened with clean water.



Cleaning the Case and Holster

Use soap and water or a mild commercial cleaner. Wipe with a damp sponge or soft rag.

Setting the Switches

The switches enable the laser beam and display backlight. To activate the laser, press . The factory settings are in the on positions. The on position is to the right and the off position is to the left.

Troubleshooting

Condition	Solution
The laser will not activate.	If the display does not turn on or shows  , replace the battery. If the display does not show  , turn on the laser switch.
The thermometer seems to be giving incorrect readings.	Check for the conditions in "Ensuring Accuracy" and "Cleaning the Focal Lens."
The displayed temperature fluctuates (but the surface temperature remains constant).	Leave the thermometer on until the displayed temperature stabilizes. (Some fluctuation is normal, especially in the tenths digit.)

Calibration

Fluke recommends that you return the thermometer annually to a Fluke Service Center for calibration, starting one year after purchase.

Emissivity of Common Materials

Object	Emissivity
Skin, human	0.98
Ice	0.96–0.98
Cement	0.96
Asphalt, Tar, Pitch	0.95–1.00
Concrete	0.94
Water	0.92–0.96
Plastic	0.90–1.00
Foods, bulk (fruits, oils, etc.)	0.85–1.00
Glass	0.85–1.00
Paint	0.80–0.97
Ceramic	0.80–0.94
Plaster	0.80–0.90
Wood	0.80–0.90
Steel, oxidized	0.80
Iron, oxidized	0.78–0.84
Copper, oxidized	0.78
Brass oxidized	0.56–0.64
Rolled stainless steel	0.45
Aluminum, oxidized	0.40
Zinc, galvanized	0.28
Copper, matte	0.22
Brass, polished	0.05
Iron, unoxidized	0.05
Copper, polished	0.02–0.07

Specifications

Measurement Range	-40 °C to +500 °C (-40 °F to +932 °F)
Operating Temperature (Ambient)	0 °C to +50 °C (+32 °F to +122 °F)
Storage Temperature	-20 °C to +70 °C (-4 °F to +158 °F), without battery
Display Resolution	Below 200°: 0.1 ° Above 200°: 1 °
Measurement Accuracy	Below 0 °C: ± 5 °C (32 °F: ±9 °F) Above 0 °C: ± 2 °C (32 °F: ±4 °F) Above 100 °C: ± 2 % of reading [Ambient: 25 °C ± 3 °C (77 °F ± 5 °F)]
Temperature Coefficient	> 400 °C (752 °F): ±0.06 % reading ≤ 400 °C (752 °F): ±0.24 % reading [Ambient:< 22 °C (72 °F); > 28 °C (82 °F)]
Response Time	0.8 second (for 95 % response)
Spectral Response	8 μm to 14 μm nominal
Field of View/Target Size	8:1; 25 mm (1 in) minimum spot size
Laser beam divergence	< 0.01 radian
Repeatability	± 1 % of reading or ±1 °, whichever is greater
Emissivity	Fixed at 0.95
Humidity	10 % to 90 % RH non-condensing
Altitude	Storage: 0 km to 12 km (40,000 ft) Operating: 0 km to 3 km (10,000 ft)
Sensor Element	Thermopile
Power Supply	2 AA alkaline batteries, not installed
Battery Life	> 15 hours with laser and backlight activated (> 4000 individual measurements under typical conditions)
Backlight	Auto-on under low-light conditions.
Hold	Temperature value is held on the screen for 20 seconds.
Dimensions	38.1 mm H × 63.5 mm W × 185.4 mm L (1.5 in H × 2.5 in W × 7.3 in L)
Weight	283.5 g (10 oz)

Safety/Regulatory Compliance	CE Certification  Approval US 21 CFR Subchapter J Part 1040.10 IEC 60825-1 (1998-01) Edition 1.1 EN 60825-1:1994/A11:1996
---------------------------------	--

Laser Safety Warning

The following laser safety warning appears on the top, back of the thermometer and the holster.

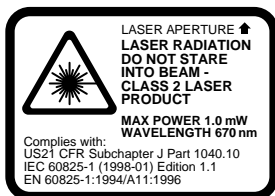

aab05f.eps

Warranty

LIMITED WARRANTY & LIMITATION OF LIABILITY

This Fluke product will be free from defects in material and workmanship for 1 year from the date of purchase. This warranty does not cover fuses, disposable batteries or damage from accident, neglect, misuse or abnormal conditions of operation or handling. Resellers are not authorized to extend any other warranty on Fluke's behalf. To obtain service during the warranty period, send your defective tester to the nearest Fluke Authorized Service Center with a description of the problem.

THIS WARRANTY IS YOUR ONLY REMEDY. NO OTHER WARRANTIES, SUCH AS FITNESS FOR A PARTICULAR PURPOSE, ARE EXPRESSED OR IMPLIED. FLUKE IS NOT LIABLE FOR ANY SPECIAL, INDIRECT, INCIDENTAL OR CONSEQUENTIAL DAMAGES OR LOSSES, ARISING FROM ANY CAUSE OR THEORY. Since some states or countries do not allow the exclusion or limitation of an implied warranty or of incidental or consequential damages, this limitation of liability may not apply to you.

Fluke Corporation
 P.O. Box 9090
 Everett WA
 98206-9090

Fluke Europe B.V.
 P.O. Box 1186
 5602 B.D. Eindhoven
 The Netherlands